

# KITCHEN DIY flat PACK

Thank you for choosing Blue Crane Woodcraft's  
DIY flat PACK.

Please visit our website if you have any queries,  
or if you require more information

[www.bluecranewoodcraft.co.za](http://www.bluecranewoodcraft.co.za)

# 1

**What you will need:**

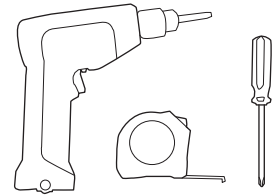







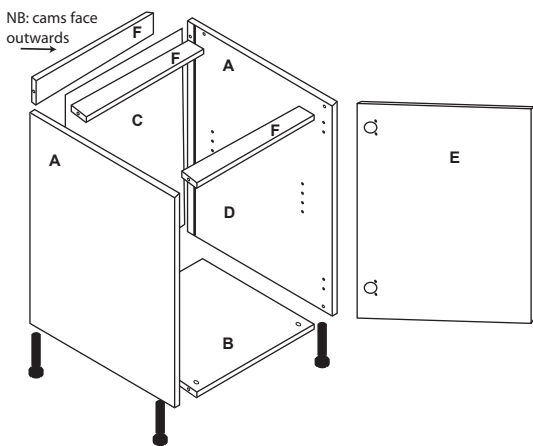

**NOT included in your unit pack:**

Handles  
Worktops  
Fillers  
Floorboards  
Cornices  
Glass

# 2

**Each unit includes:**



- A 2x side panels  cams
- B 1x base  dowels
- B 1x top (WALL & TALL)  wall anchors
- C 2x masonite back  4x shelf supports per shelf
- D adjustable shelf/shelves  hinges
- E door/s FOR FLOOR & TALL UNITS
- F cleats  4x adjustable legs with 8x16 screws
-  8x30 screws  2x floorboard clip

# 3

**Assemble units as follows:**

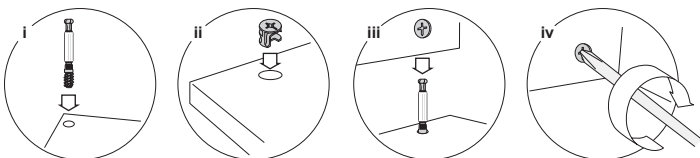

- Step 1 Fit dowels into side panels (A)
- Step 2 Slide masonite back (C) into one side
- Step 3 Attach base and cleats (B & F)
- Step 4 Fit other side panel (A)
- Step 5 Tighten cams

# 4

**Final installation:**

- Attach adjustable legs
- Use wall anchors to attach unit to wall
- Drill 100mm from side
- Attach door/s & fit shelf/shelves

